

Carmon Creek



7	Revision	02-09-2015	MR				
6	As Built	21-07-2015	MR				
5	Revision	11-02-2015	MR				
4	Revision	29-01-2015	MR				
3	Revision	16-01-2015	MR				
2	Revision	13-11-2014	MR				
1	First issue	22-10-2014	MR				
Rev	Description	Date	Drawn	Chkd. 1	Chkd. 2	Approved	Review AI

REVISIONS

PROJECT:	CARMON CREEK	Number of Pages including this cover page: 19
CLIENT:	SHELL CANADA ENERGY	

Title: **OT-HRSG W/S analyser system:
General arrangement drawing**

	NEM Energy by B.U. Industrial & Utility Boilers Demmersweg 140, 7556 BN Hengelo, The Netherlands Telephone +31 74 8515 888, Telefax +31 74 8515 889	Shell Document number: CCK-1371-MX-4018-000-00154-001	Rev:
	Internal Distribution:	Size: A4	NEM Document number: 36026-617-14-126

Name : General arrangement drawing
Doc. no. : 36026-617-14-126
Rev. no. : 7

TABLE OF CONTENTS

	NEM DOCUMENT	REV	MIA Drawing nr :	Page
C	36026-617-14-126	7	Cover Sheet	1
C	36026-617-14-126	7	Table of Contents	2
	36026-617-14-126-001	D	01000501	3
	36026-617-14-126-002	C	01000502	4
	36026-617-14-126-003	C	01000503	5
	36026-617-14-126-004	B	01000504	6
	36026-617-14-126-005	D	01000505	7
	36026-617-14-126-006	C	01000506	8
	36026-617-14-126-007	C	01000507	9
	36026-617-14-126-009	A	01000509	10
C	36026-617-14-126-010	D	01000510	11
	36026-617-14-126-011	D	02000501	12
	36026-617-14-126-012	C	02000502	13
	36026-617-14-126-013	D	02000503	14
	36026-617-14-126-014	C	02000504	15
	36026-617-14-126-015	A	02000509	16
C	36026-617-14-126-016	B	02000510	17
	36026-617-14-126-017	0	02000511	18
	36026-617-14-126-018	0	02000512	19

C = Changed
D = Deleted
N = New

Parts list position	Description	
10	MEG IN / OUT	Flange: DN100 RF
11	Drain	Flange: DN50 RF
20	Steam / Water IN	Bulkhead union 3/8"
4	Ventilation	375 x 375 mm
	Beacon / Horn	CSA / Ex Zone 2
7	Outside light	CSA / Ex Zone 2
3	Airconditioning	CSA / Ex Zone 2

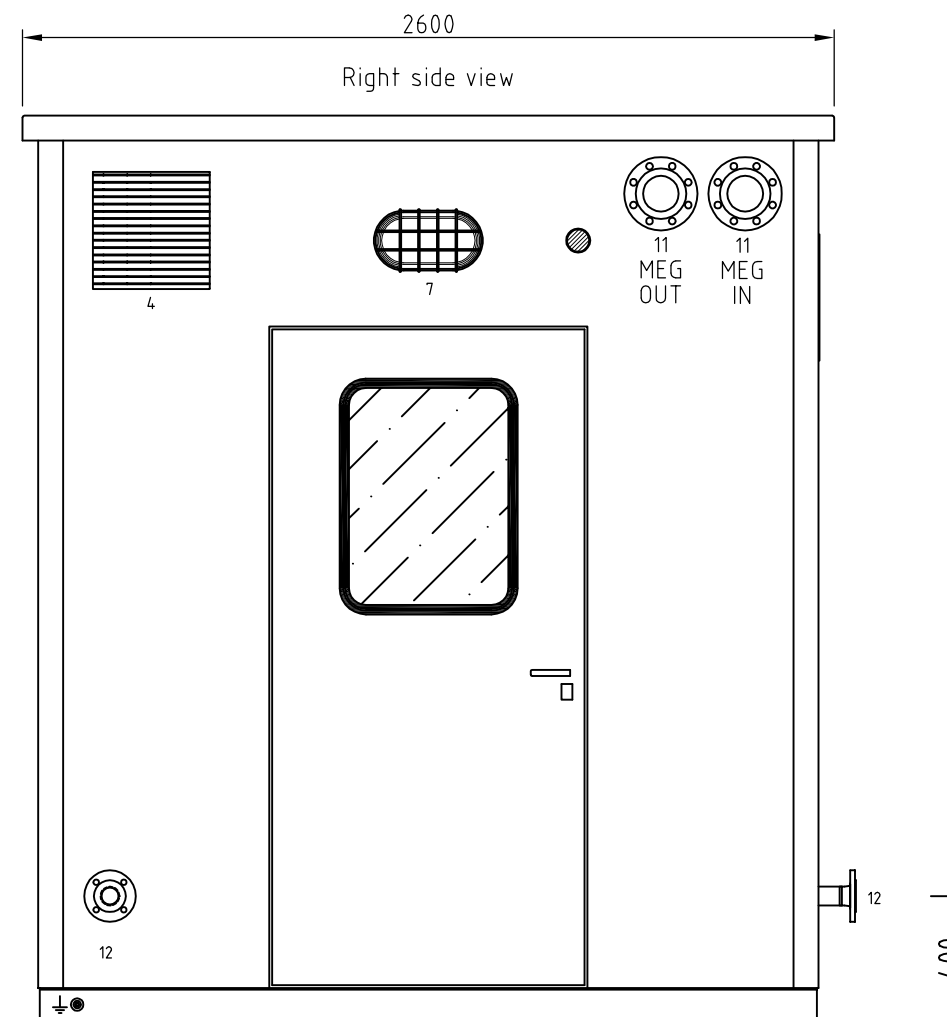
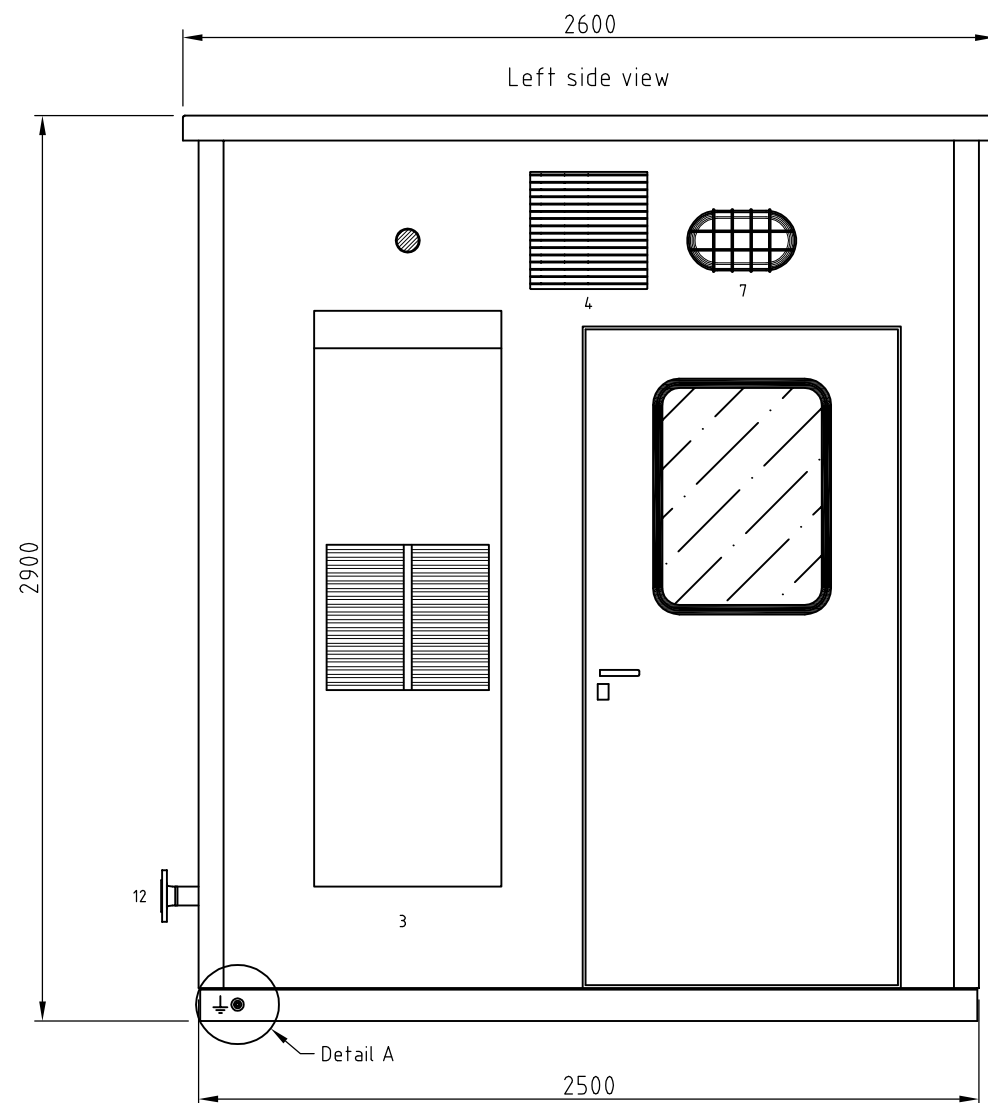

Detail A
Earth boss M10

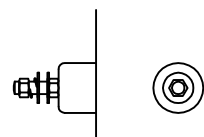

NOTE:
Cable entry for site connection not foreseen on shelter

Shelter dimensions:
2900 x 12000 x 2500mm (HxLxW)
Weight: +/- 4700 kg

Shelter color:
RAL 7035

Rev.	Date	Designer	Checked	Approved	Approved	Remark
D	16.07.2015	PvdS	MR			Revision
C	10.02.2015	PvdS	MR			Revision
B	30.12.2014	PvdS	MR			Revision
A	10.11.2014	MN	MR			Revision
0	22.09.2014	MN	MR			For approval



Client: NEM Energy BV (Hengelo)
Project: Sample Conditioning Systems
Location: Carmon Creek
Client ref.: 36026
36026-617-14-126-001



Multi Instruments Analytical B.V.
Edisonweg 1
4207 HE
Gorinchem
The Netherlands
Email: analytical@multi-instruments.nl
Web: www.multi-instruments.nl
Tel.: +31 (0)183 62 88 88
Fax: +31 (0)183 62 81 82

Dim.: mm	MIA Order nr.: S04140259
Scale: 1: 25	MIA Drawing nr.: 01000501
Form.: A3	File.: V:\Data\Project\414xxxx\4140259 NEM\Acad*.dwg
 American Projection	Erection drawing
	Shelter, HRSG 1
	Sheet: 01

1 2 3 4 5 6 7 8 9 0

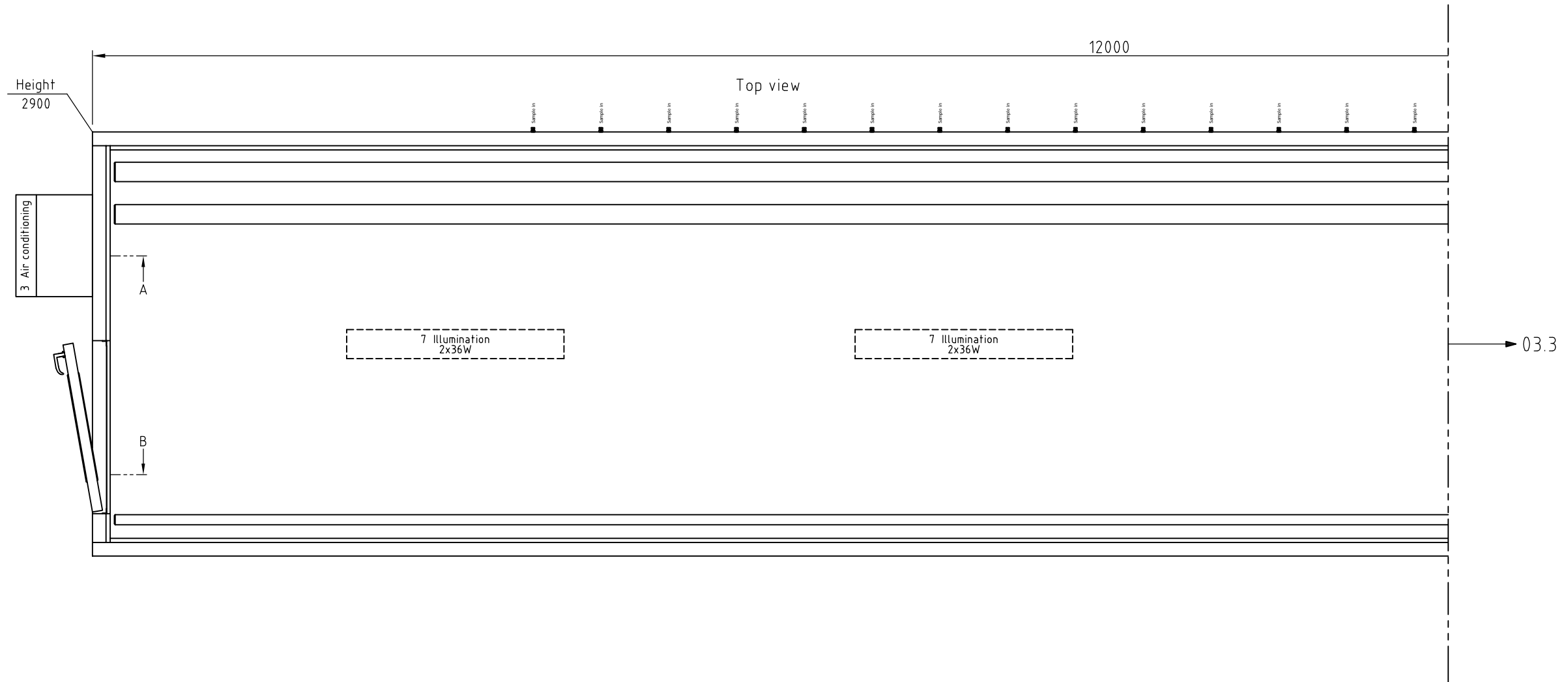

Shelter dimensions:
2900 x 12000 x 2500mm (HxLxW)
Weight: +/- 4700 kg

Shelter color:
RAL 7035

Rev.	Date	Designer	Checked	Approved	Approved	Remark
D						
C	16.07.2015	PvdS	MR			Revision
B	30.12.2014	PvdS	MR			Revision
A	10.11.2014	MN	MR			Revision
0	22.09.2014	MN	MR			For approval



Client: NEM Energy BV (Hengelo)
Project: Sample Conditioning Systems
Location: Carmon Creek
Client ref.: 36026
36026-617-14-126-002

Multi Instruments Analytical
Multi Instruments Analytical B.V.
Edisonweg 1
4207 HE
Gorinchem
The Netherlands
Email: analytical@multi-instruments.nl Tel.: +31 (0)183 62 88 88
Web: www.multi-instruments.nl Fax.: +31 (0)183 62 81 82

Dim.: mm	MIA Order nr.: S04140259
Scale: 1 : 30	MIA Drawing nr.: 01000502
Form.: A3	File.: V:\Data\Project\414xxxx\4140259 NEM\Acad*.dwg
 American Projection	Erection drawing
	Details shelter, HRSG 1
	Sheet: 02



1 2 3 4 5 6 7 8 9 0

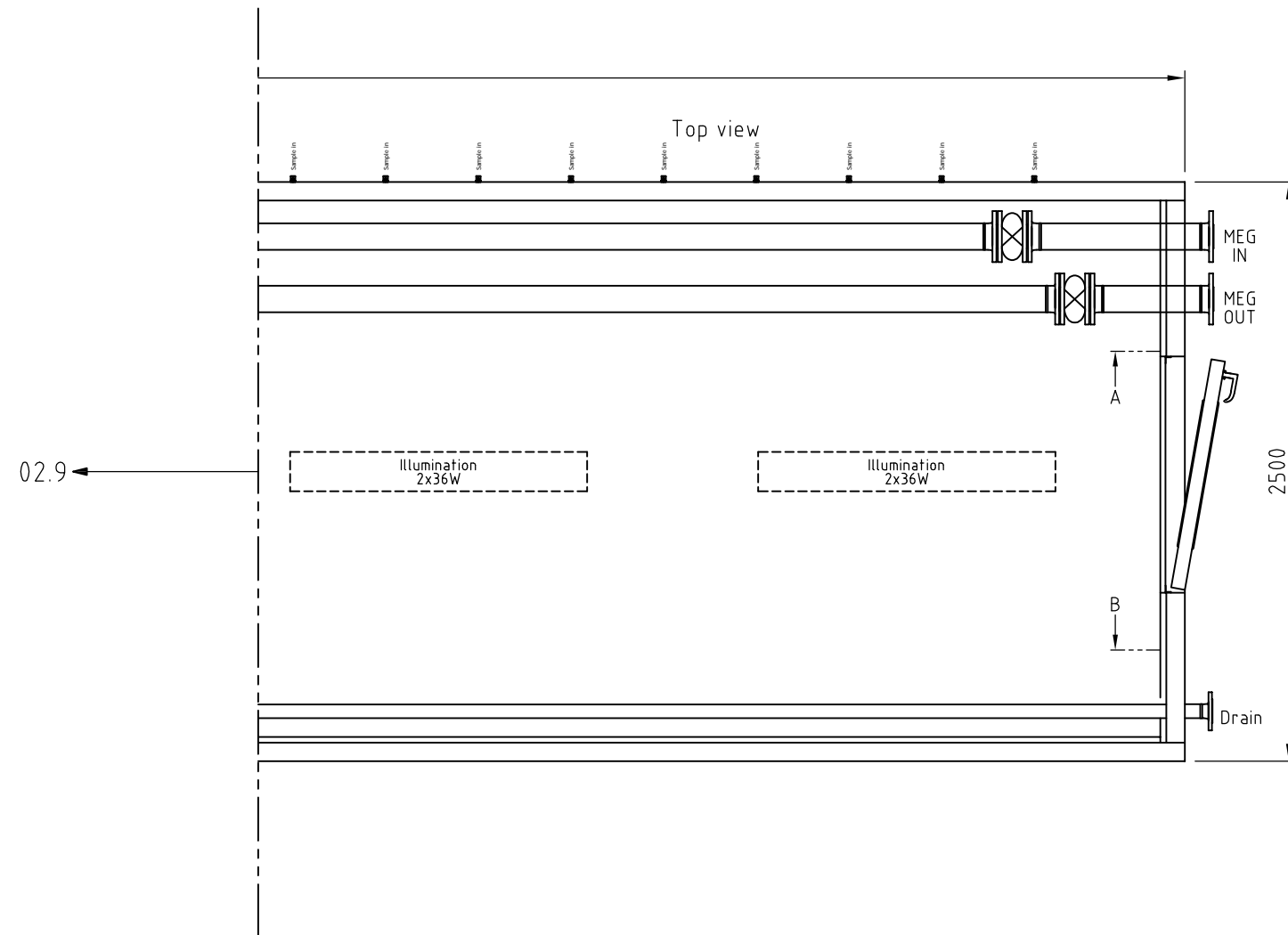

Shelter dimensions:
2900 x 12000 x 2500mm (HxLxW)
Weight: +/- 4700 kg

Shelter color:
RAL 7035

Rev.	Date	Designer	Checked	Approved	Approved	Remark
D						
C	16.07.2015	PvdS	MR			Revision
B	30.12.2014	PvdS	MR			Revision
A	10.11.2014	MN	MR			Revision
0	22.09.2014	MN	MR			For approval

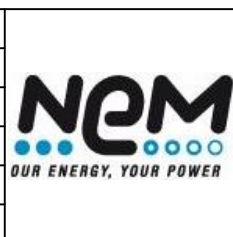

Client: NEM Energy BV (Hengelo)
Project: Sample Conditioning Systems
Location: Carmon Creek
Client ref.: 36026
36026-617-14-126-003

Multi Instruments Analytical
Multi Instruments Analytical B.V.
Edisonweg 1
4207 HE
Gorinchem
The Netherlands
Email: analytical@multi-instruments.nl
Web: www.multi-instruments.nl
Tel.: +31 (0)183 62 88 88
Fax: +31 (0)183 62 81 82

Dim.: mm	MIA Order nr.: S04140259
Scale: 1 : 30	MIA Drawing nr.: 01000503
Form.: A3	File.: V:\Data\Project\414xxxx\4140259 NEM\Acad*.dwg
 American Projection	Erection drawing
	Details shelter, HRSG 1
	Sheet: 03



1 2 3 4 5 6 7 8 9 0

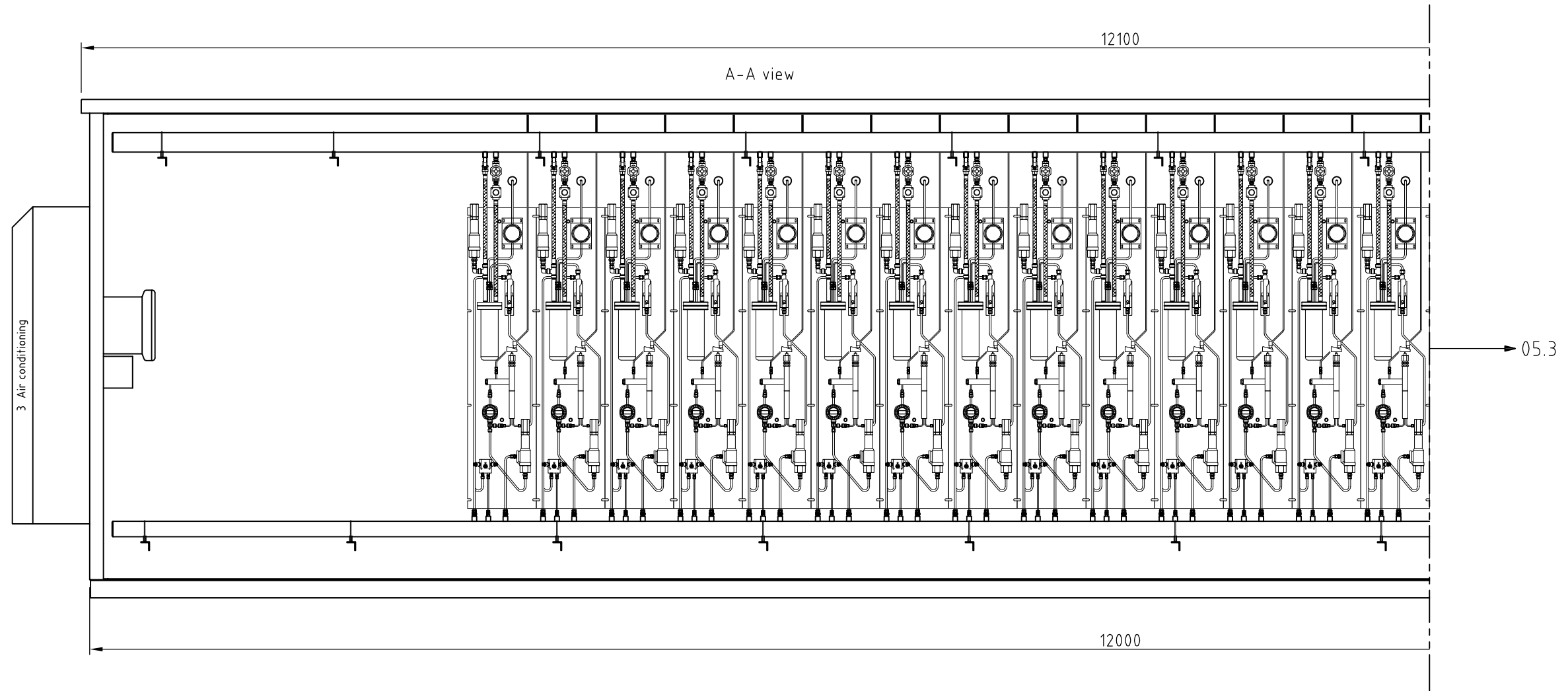

Shelter dimensions:
2900 x 12000 x 2500mm (HxLxW)
Weight: +/- 4700 kg

Shelter color:
RAL 7035

D						
C						
B	07.01.2015	PvdS	MR			Revision
A	10.11.2014	MN	MR			Revision
0	22.09.2014	MN	MR			For approval
Rev.	Date	Designer	Checked	Approved	Approved	Remark

NEM
OUR ENERGY, YOUR POWER

Client: NEM Energy BV (Hengelo)
Project: Sample Conditioning Systems
Location: Carmon Creek
Client ref.: 36026

36026-617-14-126-004

Multi Instruments Analytical

Multi Instruments Analytical B.V.
Edisonweg 1
4207 HE
Gorinchem
The Netherlands

Email: analytical@multi-instruments.nl Tel.: +31 (0)183 62 88 88
Web: www.multi-instruments.nl Fax.: +31 (0)183 62 81 82

Dim.: mm	MIA Order nr.: S04140259
Scale: 1 : 30	MIA Drawing nr.: 01000504
Form.: A3	File.: V:\Data\Project\414xxxx\4140259 NEM\Acad*.dwg
 American Projection	Erection drawing
	Details shelter, HRSG 1
	Sheet: 04



1 2 3 4 5 6 7 8 9 0

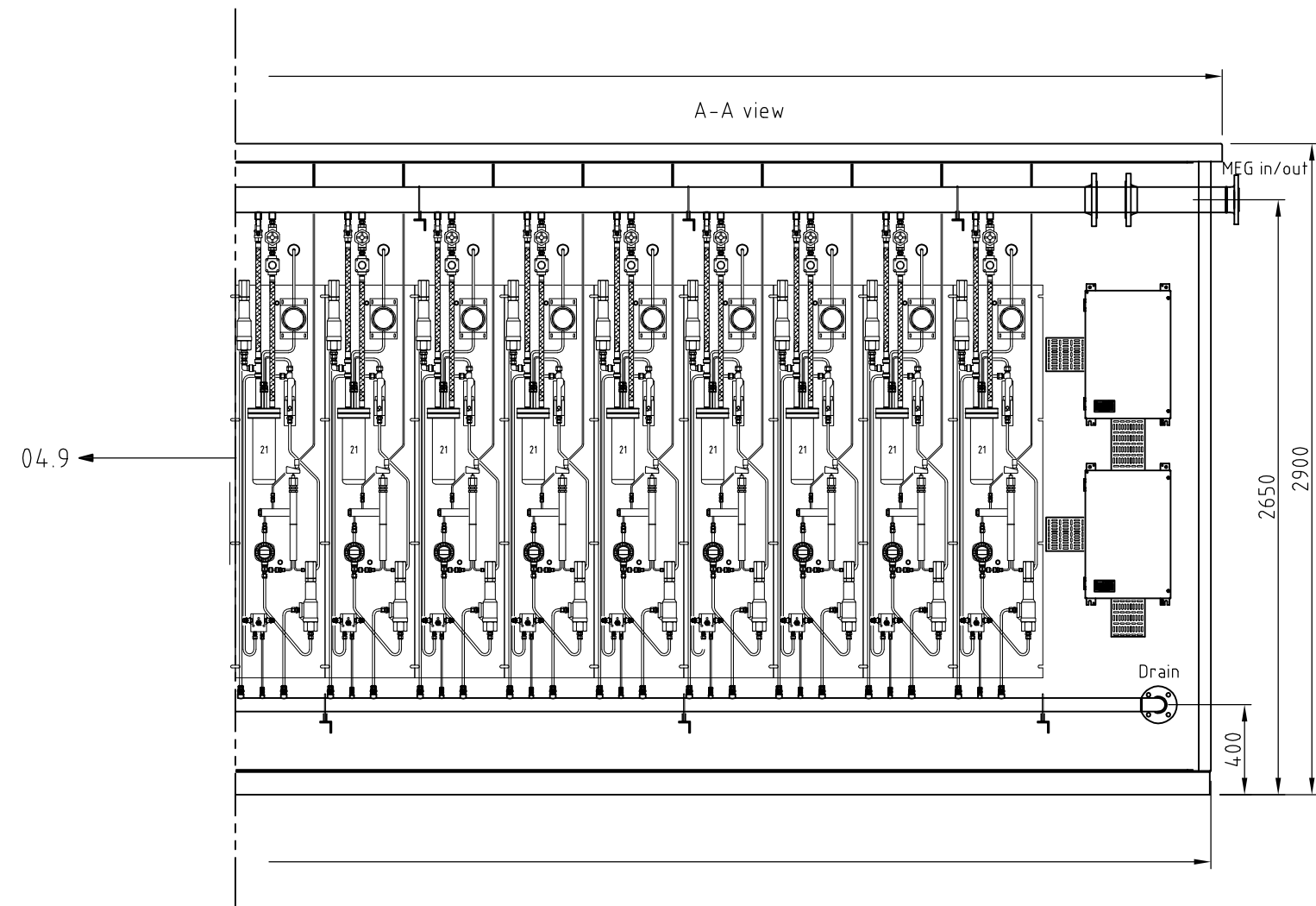

Shelter dimensions:
2900 x 12000 x 2500mm (HxLxW)
Weight: +/- 4700 kg

Shelter color:
RAL 7035

Rev.	Date	Designer	Checked	Approved	Approved	Remark
D	16.07.2015	PvdS	MR			Revision
C	13.03.2015	PvdS	MR			Revision
B	07.01.2015	PvdS	MR			Revision
A	10.11.2014	MN	MR			Revision
0	22.09.2014	MN	MR			For approval



Client: NEM Energy BV (Hengelo)
Project: Sample Conditioning Systems
Location: Carmon Creek
Client ref.: 36026
36026-617-14-126-005

Multi Instruments Analytical
Edisonweg 1
4207 HE
Gorinchem
The Netherlands
Email: analytical@multi-instruments.nl Tel.: +31 (0)183 62 88 88
Web: www.multi-instruments.nl Fax: +31 (0)183 62 81 82

Dim.: mm	MIA Order nr.: S04140259
Scale: 1 : 30	MIA Drawing nr.: 01000505
Form.: A3	File.: V:\Data\Project\414xxxx\4140259 NEM\Acad*.dwg
 American Projection	Erection drawing
	Details shelter, HRSG 1
	Sheet: 05



1 2 3 4 5 6 7 8 9 0

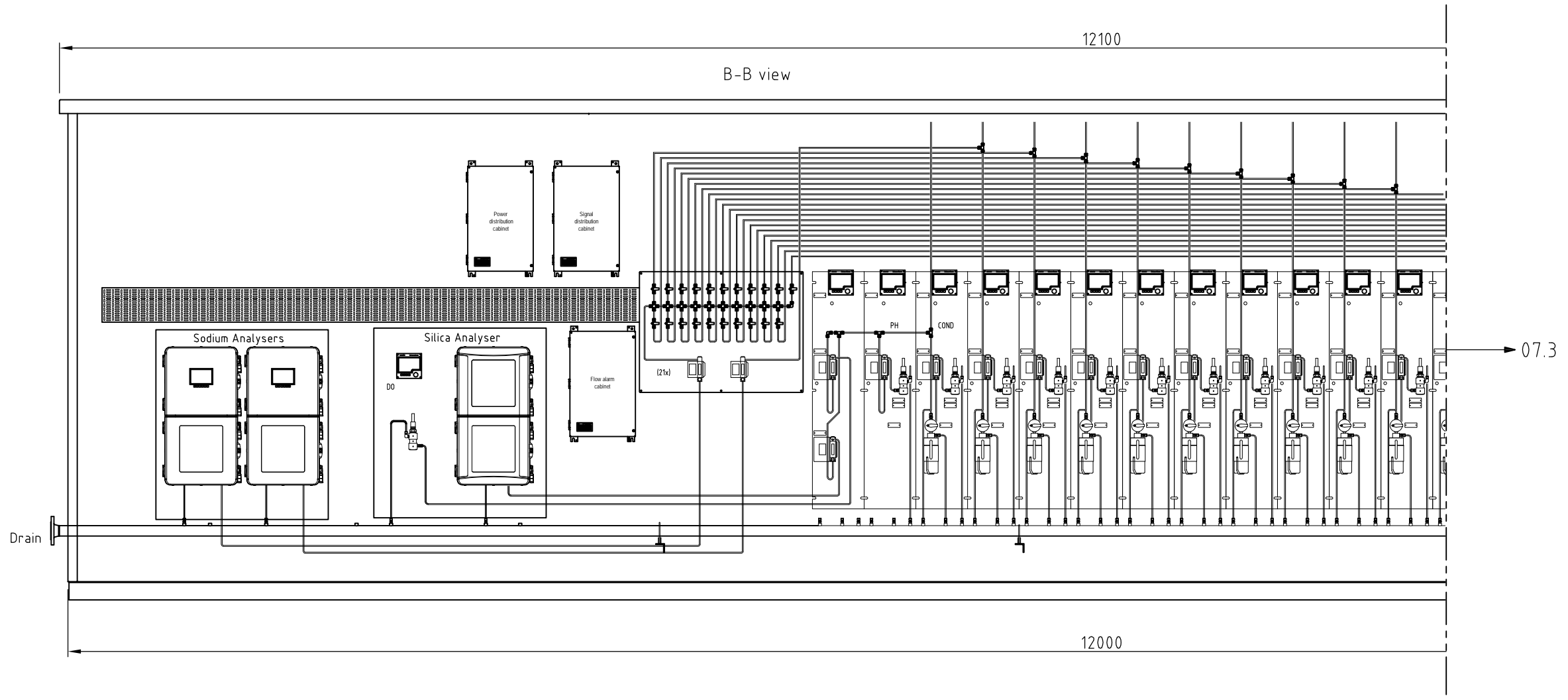

Shelter dimensions:
2900 x 12000 x 2500mm (HxLxW)
Weight: +/- 4700 kg

Shelter color:
RAL 7035

Rev.	Date	Designer	Checked	Approved	Approved	Remark
D						
C	15.07.2015	PvdS	MR			Revision
B	07.01.2015	PvdS	MR			Revision
A	10.11.2014	MN	MR			Revision
0	22.09.2014	MN	MR			For approval

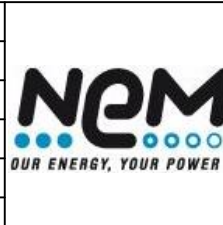

Client: NEM Energy BV (Hengelo)
Project: Sample Conditioning Systems
Location: Carmon Creek
Client ref.: 36026
36026-617-14-126-006

Multi Instruments Analytical
Edisonweg 1
4207 HE
Gorinchem
The Netherlands

Email : analytical@multi-instruments.nl Tel. : +31 (0)183 62 88 88
Web : www.multi-instruments.nl Fax. : +31 (0)183 62 81 82

Dim.: mm	MIA Order nr.: S04140259
Scale: 1 : 30	MIA Drawing nr.: 01000506
Form.: A3	File.: V:\Data\Project\414xxxx\4140259 NEM\Acad*.dwg
 American Projection	Erection drawing
	Details shelter, HRSG 1
	Sheet: 06



1 2 3 4 5 6 7 8 9 0

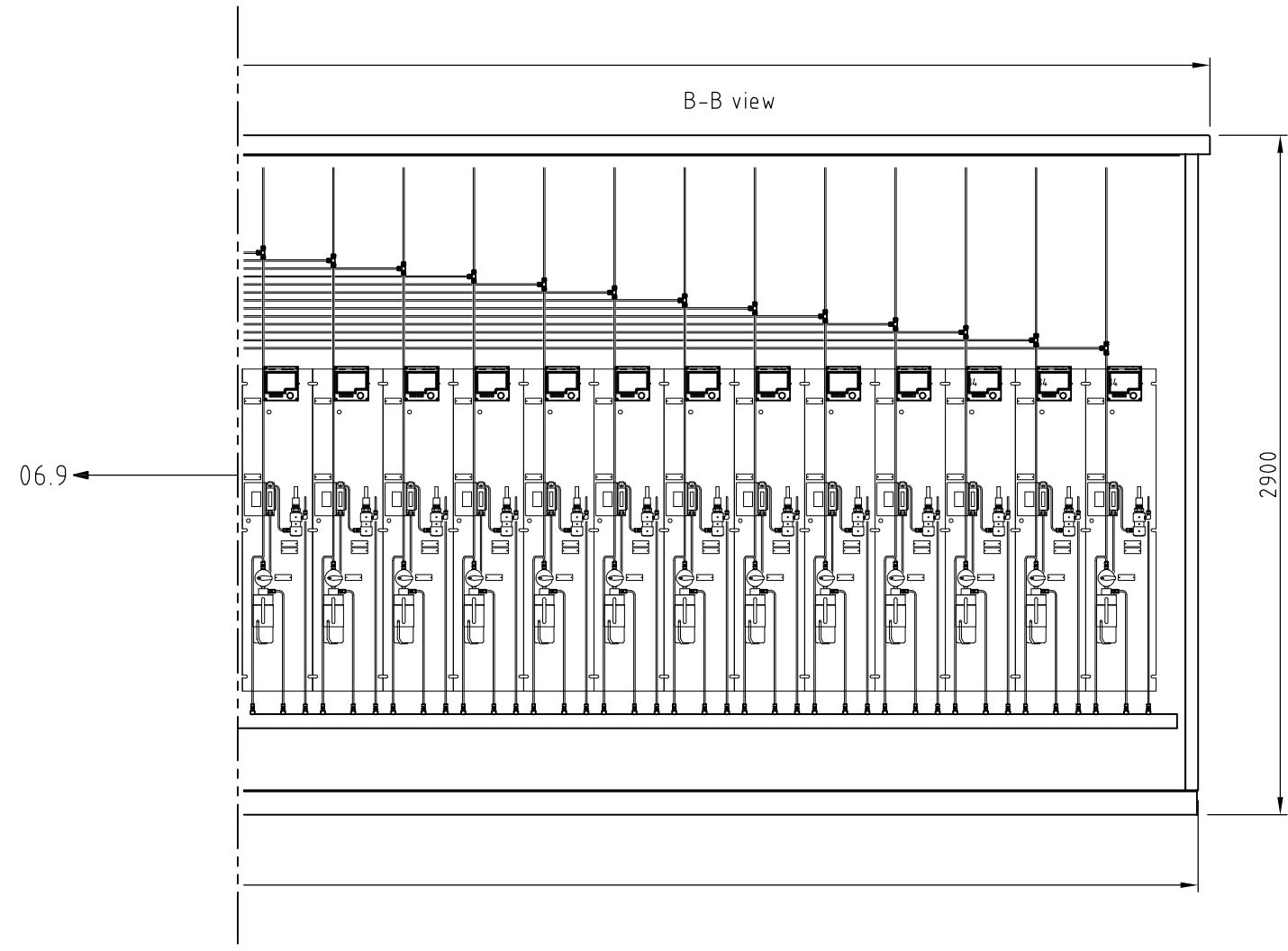

Shelter dimensions:
2900 x 12000 x 2500mm (HxLxW)
Weight: +/- 4700 kg

Shelter color:
RAL 7035

Rev.	Date	Designer	Checked	Approved	Approved	Remark
D						
C	16.07.2015	PvdS	MR			Revision
B	07.01.2015	PvdS	MR			Revision
A	10.11.2014	MN	MR			Revision
0	22.09.2014	MN	MR			For approval



Client: NEM Energy BV (Hengelo)
Project: Sample Conditioning Systems
Location: Carmon Creek
Client ref.: 36026
36026-617-14-126-007

Multi Instruments Analytical
Edisonweg 1
4207 HE
Gorinchem
The Netherlands
Email: analytical@multi-instruments.nl
Web: www.multi-instruments.nl

Multi Instruments Analytical B.V.
Dim.: mm
Scale: 1 : 30
Form.: A3
American Projection
MIA Order nr.: S04140259
MIA Drawing nr.: 01000507
File.: V:\Data\Project\414xxxx\4140259 NEM\Acad*.dwg
Erection drawing
Details shelter, HRSG 1
Sheet: 07
B-B view

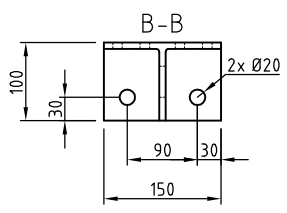
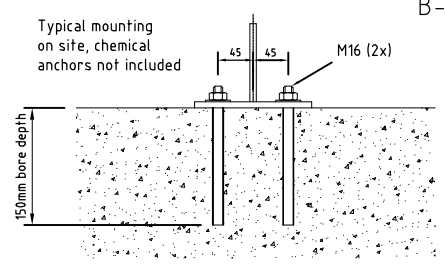
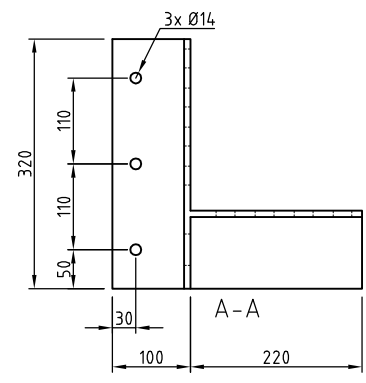
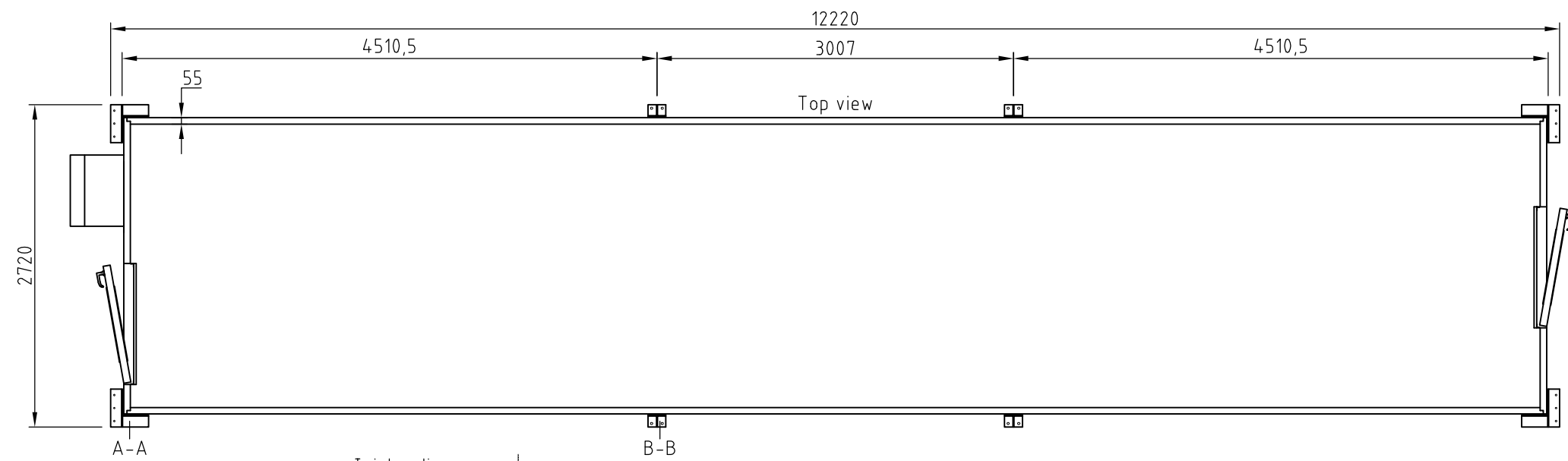
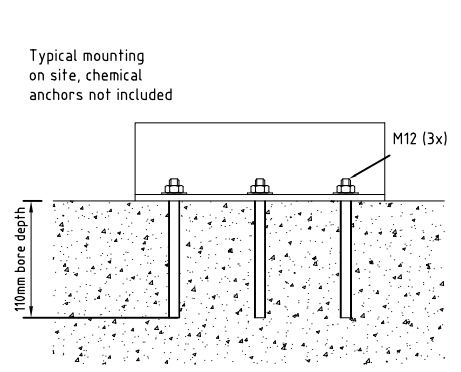
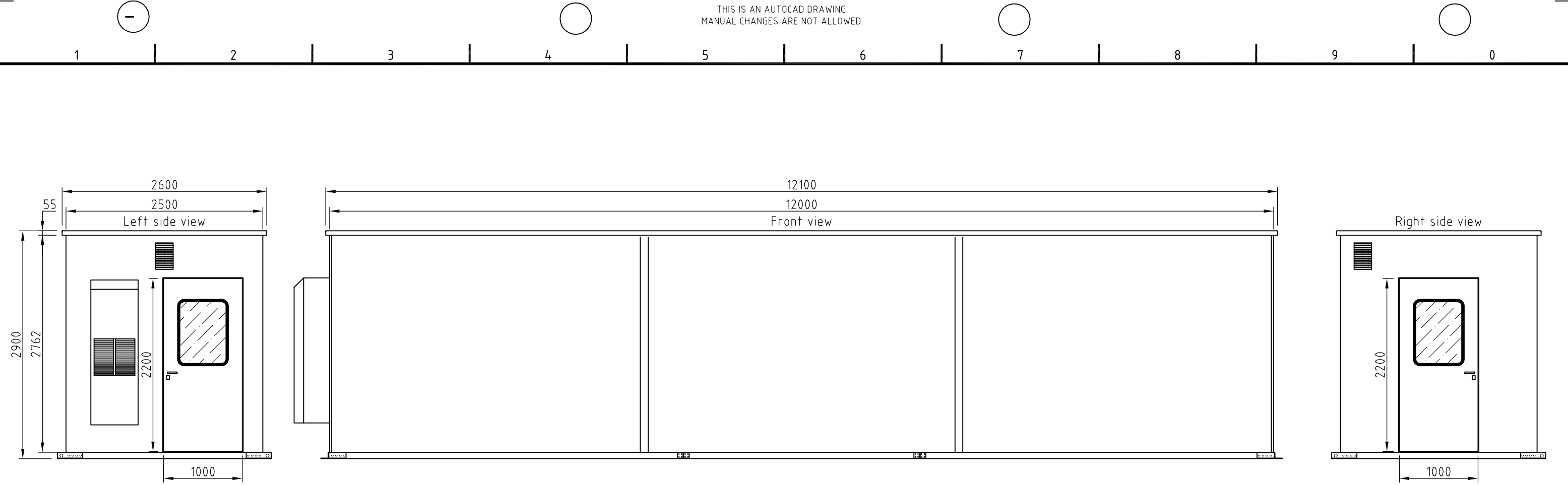

Shelter dimensions:
2900 x 12000 x 2500mm (HxLxW)
Weight: +/- 4700 kg
Shelter color:
RAL 7035

D						
C						
B						
A	29.01.2015	PvdS	MR			Revision
0	10.12.2014	MN	MR			For information purpose only
Rev.	Date	Designer	Checked	Approved	Approved	Remark

NEM
OUR ENERGY, YOUR POWER

Client: NEM Energy BV (Hengelo)
Project: Sample Conditioning Systems
Location: Carmon Creek
Client ref.: 36026

36026-617-14-126-009

Multi Instruments Analytical

Multi Instruments Analytical B.V.
Edisonweg 1
4207 HE
Gorinchem
The Netherlands

Email: analytical@multi-instruments.nl
Web: www.multi-instruments.nl

Tel.: +31 (0)183 62 88 88
Fax: +31 (0)183 62 81 82

Dim.: mm	MIA Order nr.: S04140259
Scale: 1:50	MIA Drawing nr.: 01000509
Form.: A3	File.: V:\Data\Project\414xxxx\4140259 NEM\Acad*.dwg
American Projection	Erection drawing
	Shelter 12 Meter Foundation details
	Sheet: 09

Design drawing typical for all systems :

HRSG 1 serial nr.: 4140259-04

HRSG 2 serial nr.: 4140259-05

HRAG 3 serial nr.: 4140259-06

Aproximate total weight: 750 Kg

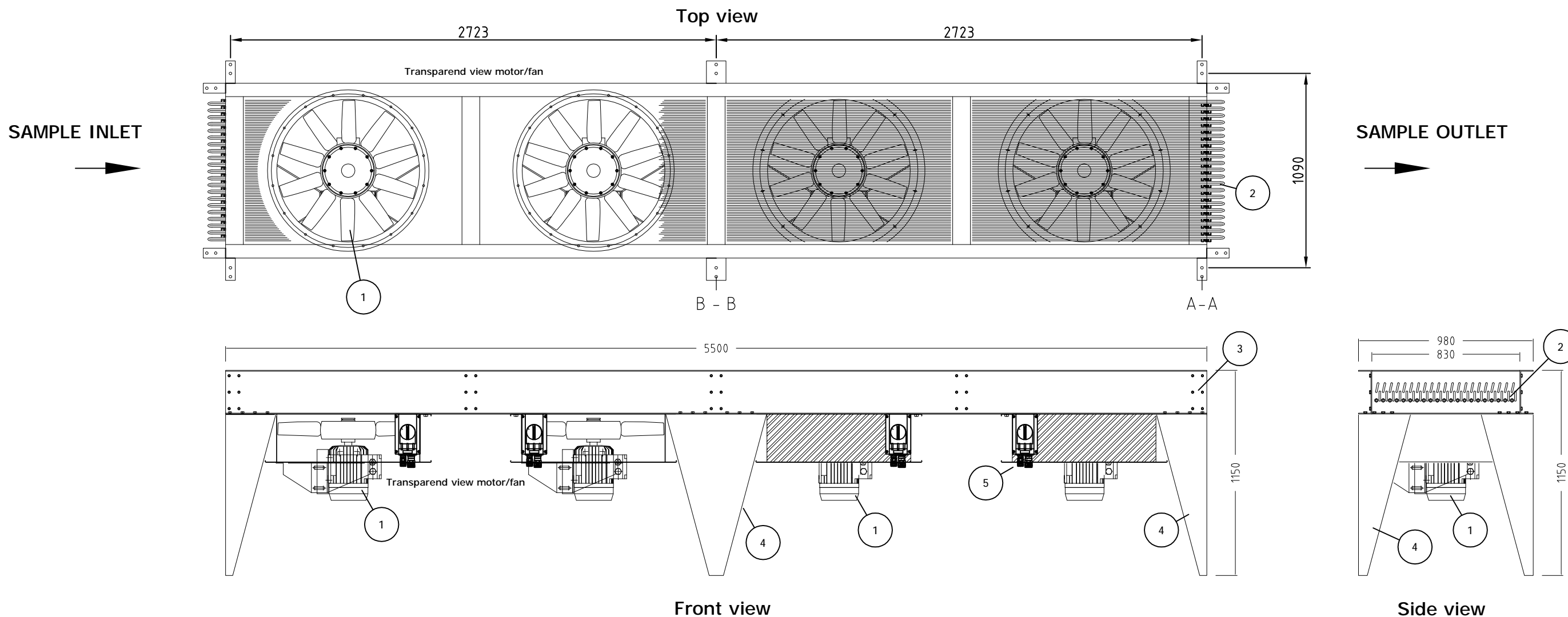

For airduct details see drawing 02000510

Rev.	Date	Designer	Checked	Approved	Approved	Remark
D	01.09.2015	PvdS	MR			Revision
C	12.03.2015	PvdS	MR			Revision
B	29.01.2015	PvdS	MR			Revision
A	10.12.2014	PvdS	MR			Revision
0	04.12.2014	PvdS	MR			For approval

name/description	material/design	quantity
5	Safety switch	CEAG GHG2622301L0002
4	Leg	AISI316
3	Tube bank shell	AISI316
2	Tube bank	Alloy 825 $\frac{3}{8}$ " x 0.065"
1	Fan	Hot dipped galvanised steel
		>567 meter
part list		

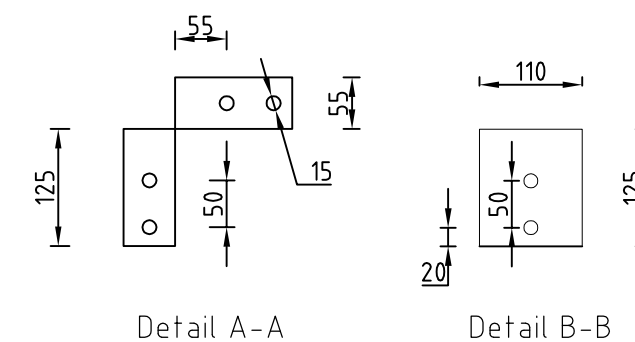
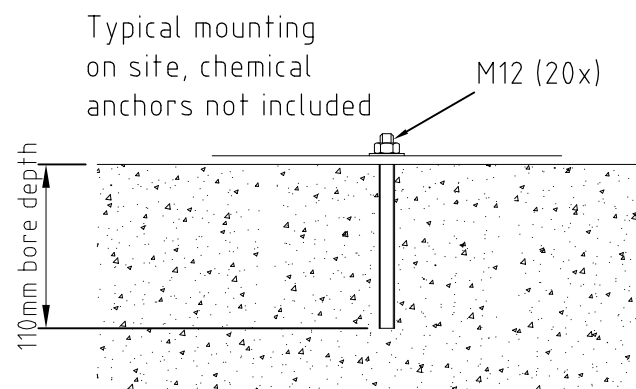

Rev.	Date	Designer	Checked	Approved	Approved	Remark
D	01.09.2015	PvdS	MR			Revision
C	12.03.2015	PvdS	MR			Revision
B	29.01.2015	PvdS	MR			Revision
A	10.12.2014	PvdS	MR			Revision
0	04.12.2014	PvdS	MR			For approval

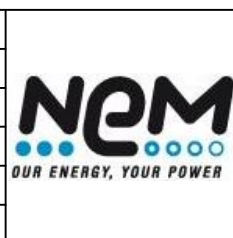

Client: NEM Energy BV (Hengelo)
Project: Sample Conditioning Systems
Location: Carmon Creek
Client ref.: 36026
36026-617-14-126-010

Multi Instruments Analytical B.V.
Edisonweg 1
4207 HE
Gorinchem
The Netherlands
Email: analytical@multi-instruments.nl
Web: www.multi-instruments.nl
Tel.: +31 (0)183 62 88 88
Fax: +31 (0)183 62 81 82

Dim.: mm
Scale: 1 : 25
Form.: A3
American Projection
MIA Order nr.: S04140259
MIA Drawing nr.: 01000510
File.: V:\Data\Project\414xxxx\4140259 NEM\Acad*.dwg
Erection drawing
Air cooler steam samples
Foundation details
Sheet: 10

Parts list position	Description	
10	MEG IN / OUT	Flange: DN100 RF
11	Drain	Flange: DN50 RF
20	Steam / Water IN	Bulkhead union 3/8"
4	Ventilation	375 x 375 mm
	Beacon / Horn	CSA / Ex Zone 2
7	Outside light	CSA / Ex Zone 2
3	Airconditioning	CSA / Ex Zone 2

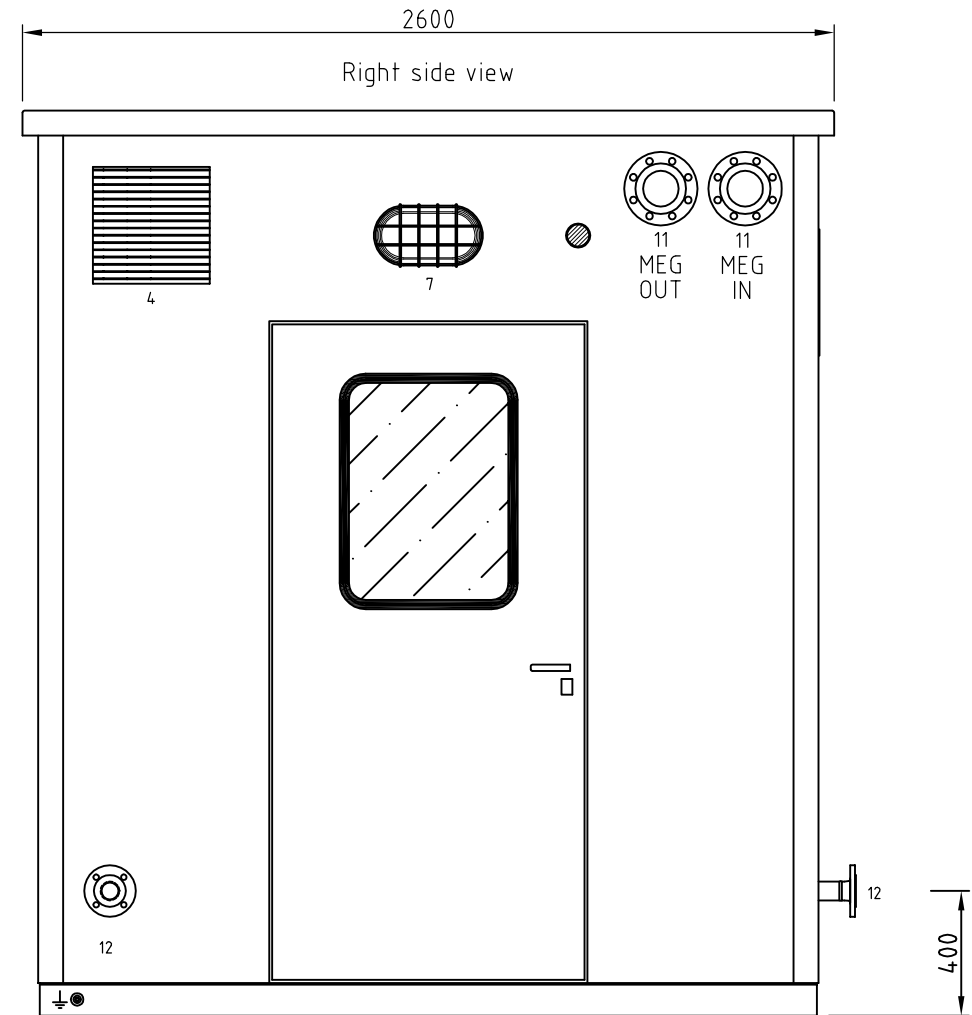
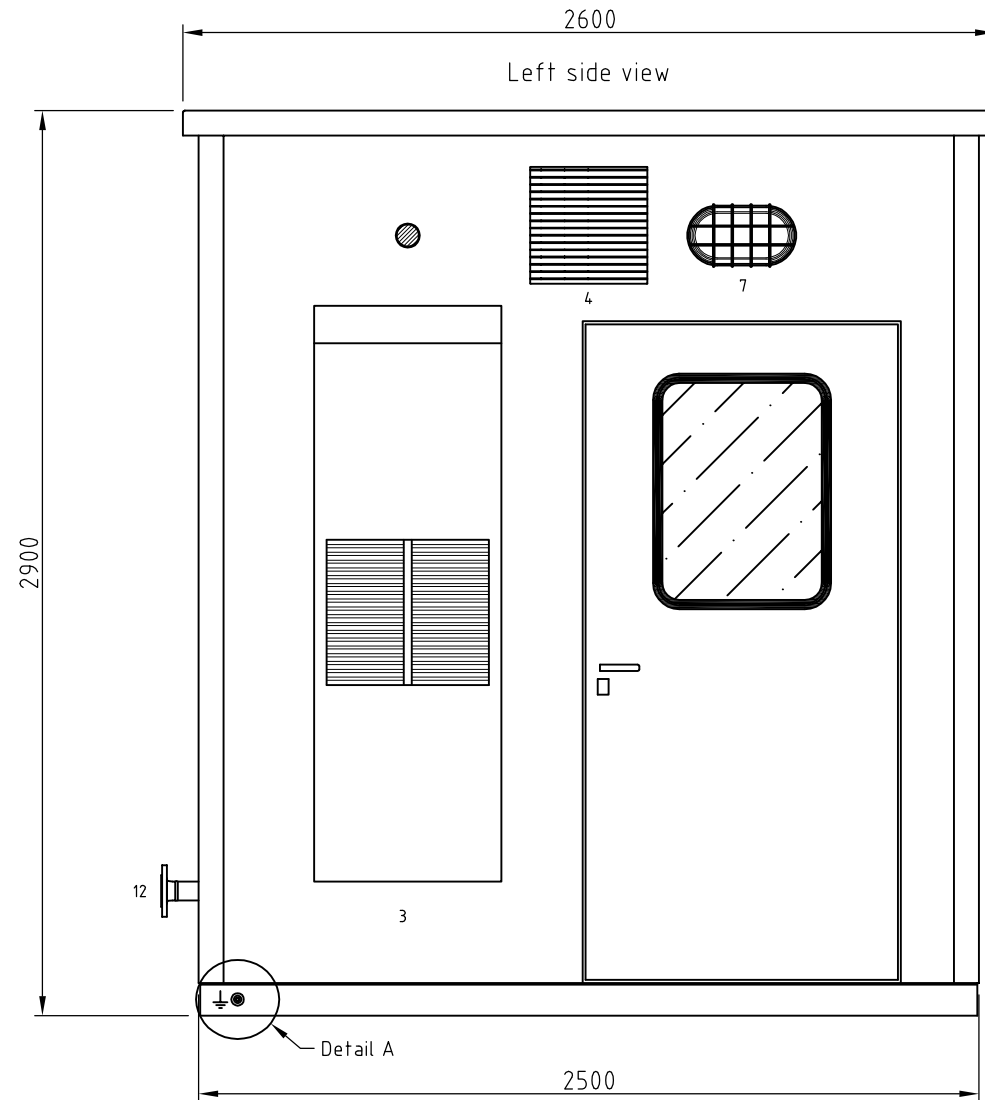

Detail A
Earth boss M10

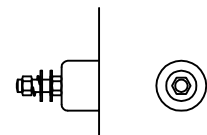

NOTE:
Cable entry for site connection not foreseen on shelter

Shelter dimensions:
2900 x 10000 x 2500mm (HxLxW)
Weight: +/- 4400 kg

Shelter color:
RAL 7035

Rev.	Date	Designer	Checked	Approved	Approved	Remark
D	16.07.2015	PvdS	MR			Revision
C	10.02.2015	PvdS	MR			Revision
B	30.12.2014	PvdS	MR			Revision
A	12.11.2014	MN	MR			Revision
0	22.09.2014	MN	MR			For approval

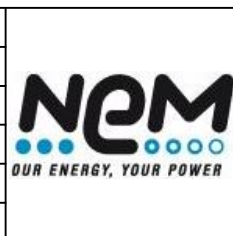

Client:	NEM Energy BV (Hengelo)
Project:	Sample Conditioning Systems
Location:	Carmon Creek
Client ref.:	36026
36026-617-14-126-011	

Multi Instruments Analytical
Edisonweg 1
4207 HE
Gorinchem
The Netherlands

Email: analytical@multi-instruments.nl Tel.: +31 (0)183 62 88 88
Web: www.multi-instruments.nl Fax.: +31 (0)183 62 81 82

Dim.: mm	MIA Order nr.: S04140259
Scale: 1: 25	MIA Drawing nr.: 02000501
Form.: A3	File.: V:\Data\Project\414xxxx\4140259 NEM\Acad*.dwg
American Projection	Erection drawing
	Shelter, HRSG 2
	Sheet: 01

1 2 3 4 5 6 7 8 9 0

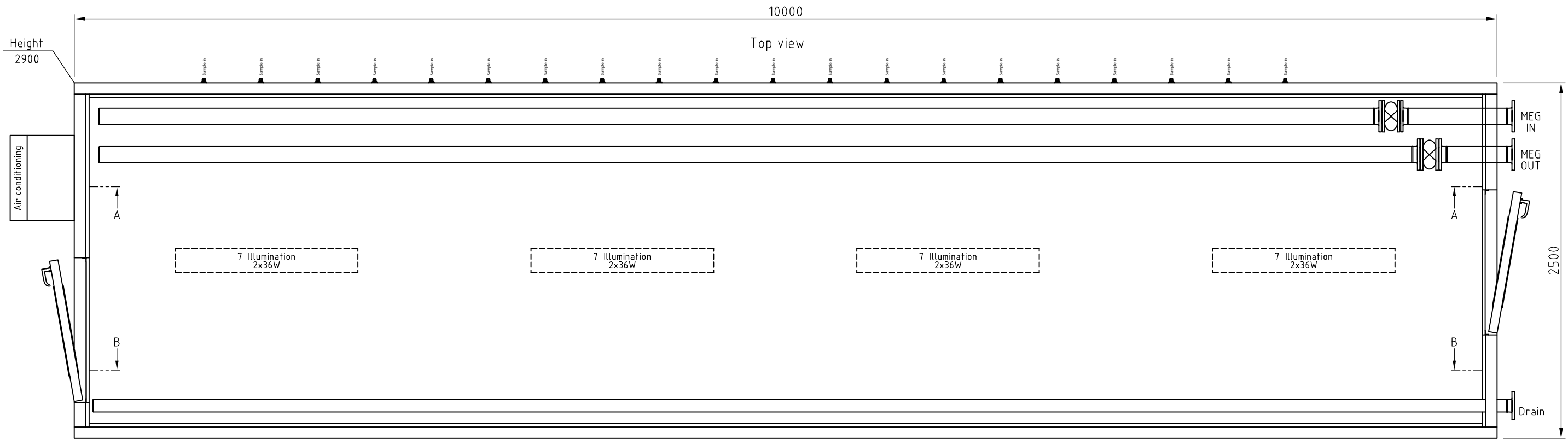

Shelter dimensions:
2900 x 10000 x 2500mm (HxLxW)
Weight: +/- 4400 kg

Shelter color:
RAL 7035

Rev.	Date	Designer	Checked	Approved	Approved	Remark
D						
C	16.07.2015	PvdS	MR			Revision
B	16.01.2015	PvdS	MR			Revision
A	12.11.2014	MN	MR			Revision
0	22.09.2014	MN	MR			For approval



Client: NEM Energy BV (Hengelo)
Project: Sample Conditioning Systems
Location: Carmon Creek
Client ref.: 36026
36026-617-14-126-012

Multi Instruments Analytical
Multi Instruments Analytical B.V.
Edisonweg 1
4207 HE
Gorinchem
The Netherlands
Email: analytical@multi-instruments.nl Tel.: +31 (0)183 62 88 88
Web: www.multi-instruments.nl Fax.: +31 (0)183 62 81 82

Dim.: mm	MIA Order nr.: S04140259
Scale: 1 : 30	MIA Drawing nr.: 02000502
Form.: A3	File.: V:\Data\Project\414xxxx\4140259 NEM\Acad*.dwg
 American Projection	Erection drawing
	Details shelter, HRSG 2
Top view	Sheet: 02



1 2 3 4 5 6 7 8 9 0

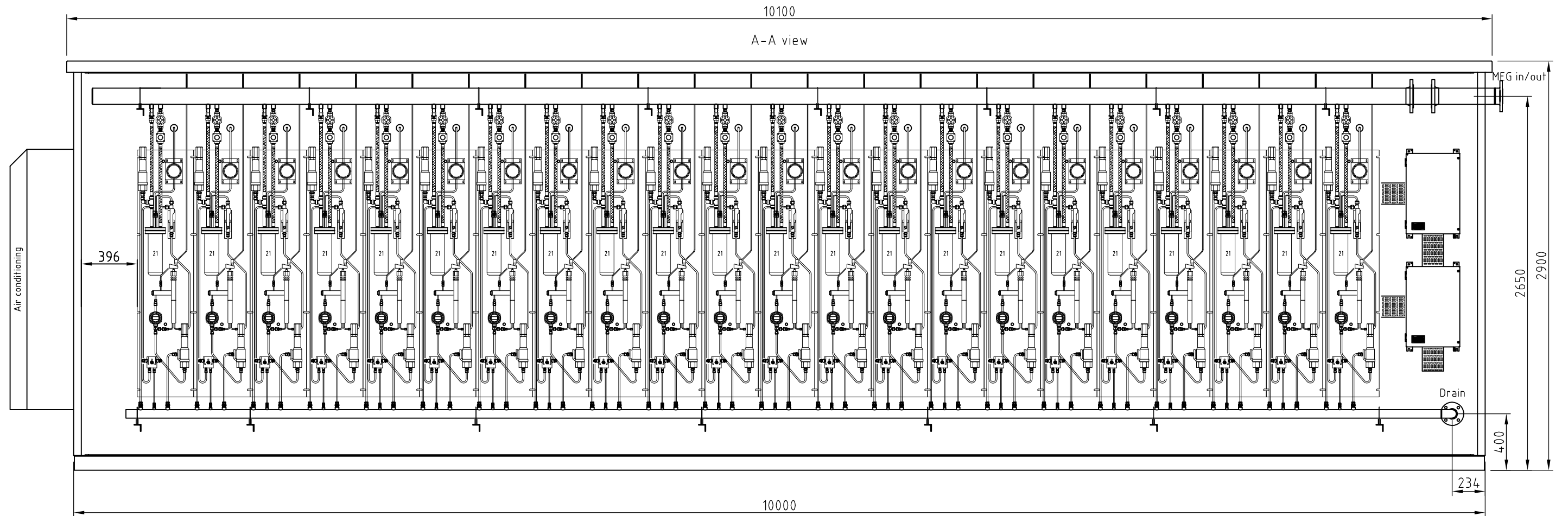

Shelter dimensions:
2900 x 10000 x 2500mm (HxLxW)
Weight: +/- 4400 kg

Shelter color:
RAL 7035

Rev.	Date	Designer	Checked	Approved	Approved	Remark
D	16.07.2015	PvdS	MR			Revision
C	13.03.2015	PvdS	MR			Revision
B	07.01.2015	PvdS	MR			Revision
A	12.11.2014	MN	MR			Revision
0	22.09.2014	MN	MR			For approval



Client: NEM Energy BV (Hengelo)
Project: Sample Conditioning Systems
Location: Carmon Creek
Client ref.: 36026
36026-617-14-126-013



Email: analytical@multi-instruments.nl
Web: www.multi-instruments.nl

Multi Instruments Analytical B.V.
Edisonweg 1
4207 HE
Gorinchem
The Netherlands

Tel.: +31 (0)183 62 88 88
Fax: +31 (0)183 62 81 82

Dim.: mm	MIA Order nr.: S04140259
Scale: 1 : 30	MIA Drawing nr.: 02000503
Form.: A3	File: V:\Data\Project\414xxxx\4140259 NEM\Acad*.dwg
 American Projection	Erection drawing
	Details shelter, HRSG 2
	Sheet: 03

1 2 3 4 5 6 7 8 9 0

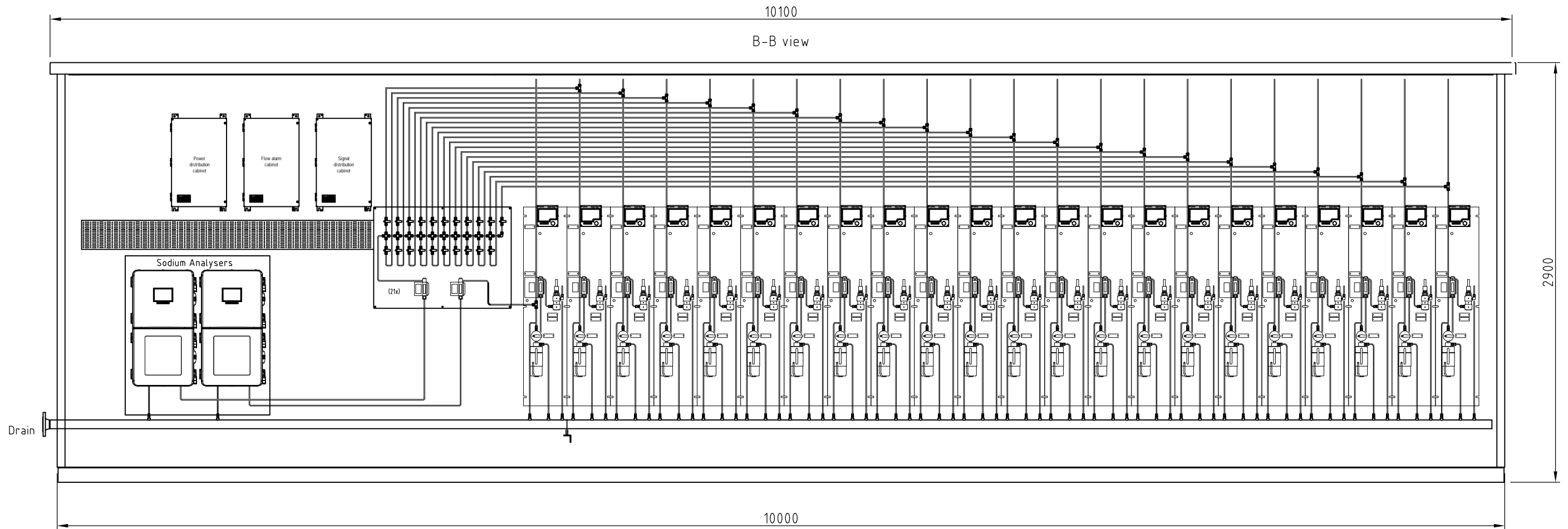

Shelter dimensions:
2900 x 10000 x 2500mm (HxLxW)
Weight: +/- 4400 kg

Shelter color:
RAL 7035

Rev.	Date	Designer	Checked	Approved	Approved	Remark
D						
C	16.07.2015	PvdS	M.R.			Revision
B	07.01.2015	PvdS	MR			Revision
A	12.11.2014	MN	MR			Revision
0	22.09.2014	MN	MR			For approval



Client: NEM Energy BV (Hengelo)
Project: Sample Conditioning Systems
Location: Carmon Creek
Client ref.: 36026
36026-617-14-126-014

Multi Instruments Analytical
Edisonweg 1
4207 HE
Gorinchem
The Netherlands
Email: analytical@multi-instruments.nl
Web: www.multi-instruments.nl

Multi Instruments Analytical B.V.
Dim.: mm
Scale: 1 : 30
Form.: A3
American Projection

MIA Order nr.: S04140259
MIA Drawing nr.: 02000504
File.: V:\Data\Project\414xxxx\4140259 NEM\Acad*.dwg
Erection drawing
Details shelter, HRSG 2
B-B view

Sheet: 04



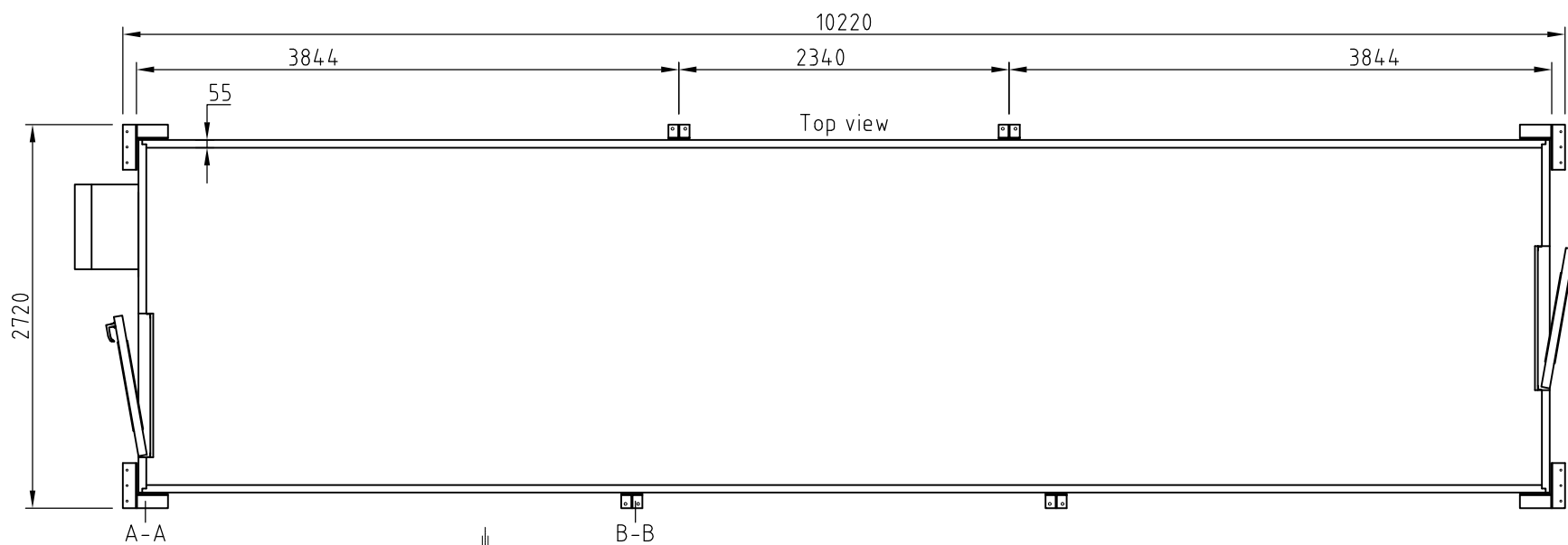
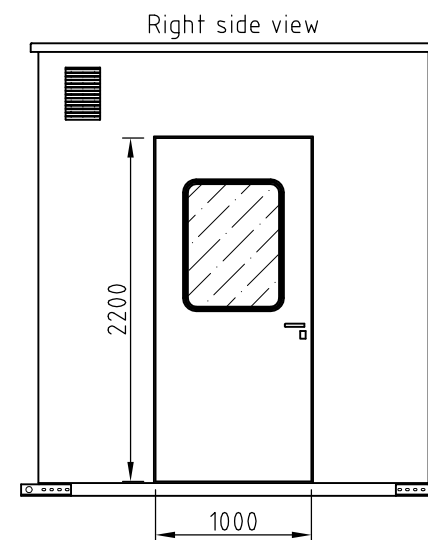
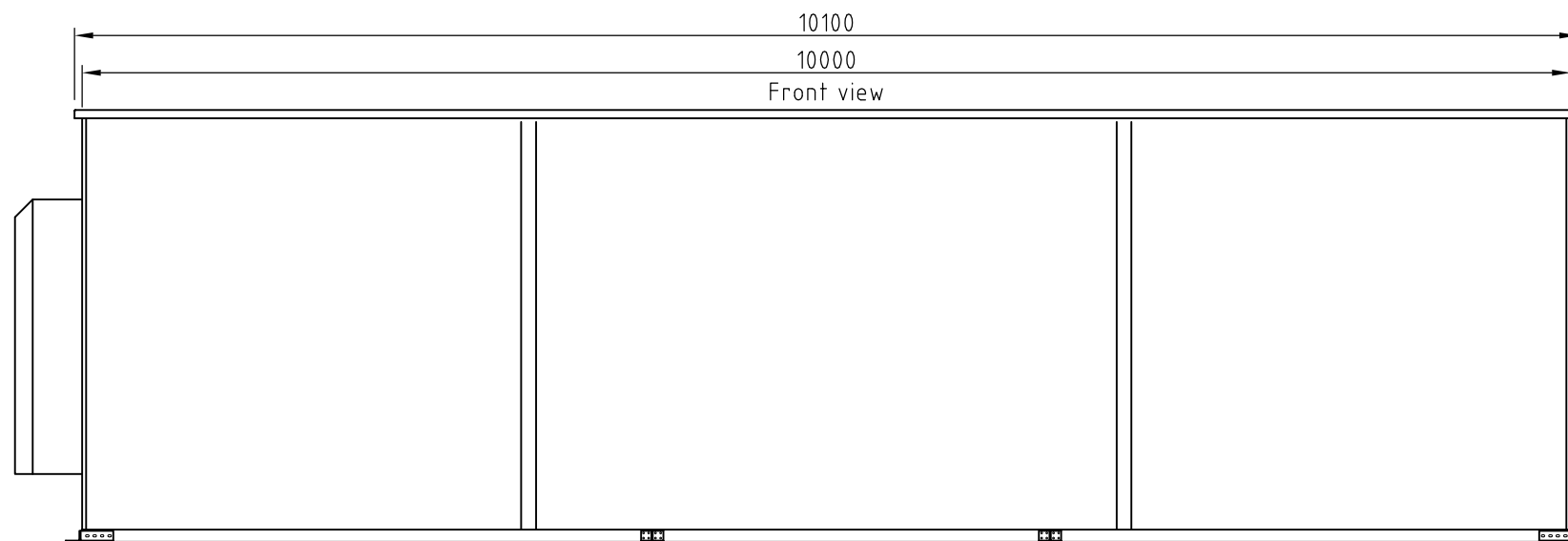
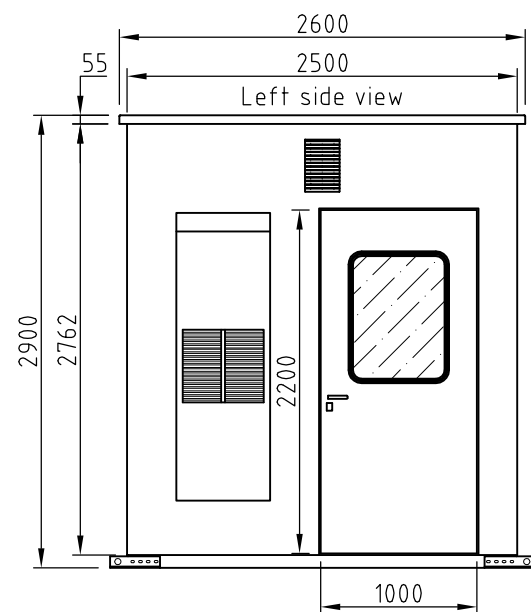

Typical mounting
on site, chemical
anchors not included

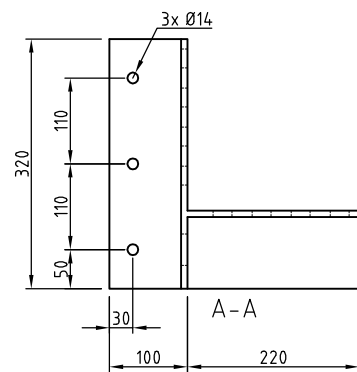
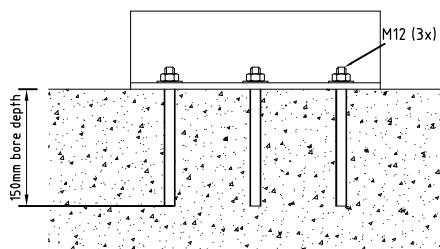

Typical mounting
on site, chemical
anchors not included

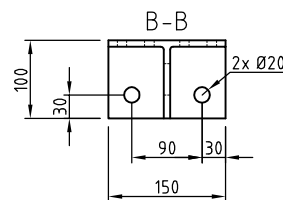
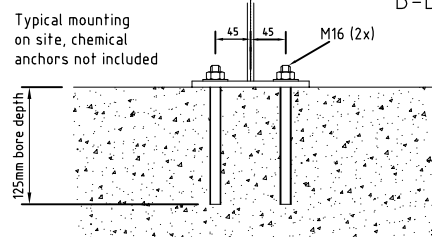

Shelter dimensions:
2900 x 10000 x 2500mm (HxLxW)
Weight: +/- 4400 kg

Shelter color:
RAL 7035

D						
C						
B						
A	29.01.2015	PvdS	MR			Revision
0	10.12.2014	MN	MR			For information purpose only
Rev.	Date	Designer	Checked	Approved	Approved	Remark



Client: NEM Energy BV (Hengelo)
Project: Sample Conditioning Systems
Location: Carmon Creek
Client ref.: 36026

36026-617-14-126-015



Multi Instruments Analytical B.V.
Edisonweg 1
4207 HE
Gorinchem
The Netherlands

Email: analytical@multi-instruments.nl
Web: www.multi-instruments.nl
Tel.: +31 (0)183 62 88 88
Fax: +31 (0)183 62 81 82

Dim.: mm	MIA Order nr.: S04140259
Scale: 1: 50	MIA Drawing nr.: 02000509
Form.: A3	File.: V:\Data\Project\414xxxx\4140259 NEM\Acad*.dwg
American Projection	Erection drawing
	Shelter 10 Meter Foundation details
	Sheet: 09

Design drawing typical for all systems :

HRSG 1 serial nr.: 4140259-04

HRSG 2 serial nr.: 4140259-05

HRAG 3 serial nr.: 4140259-06

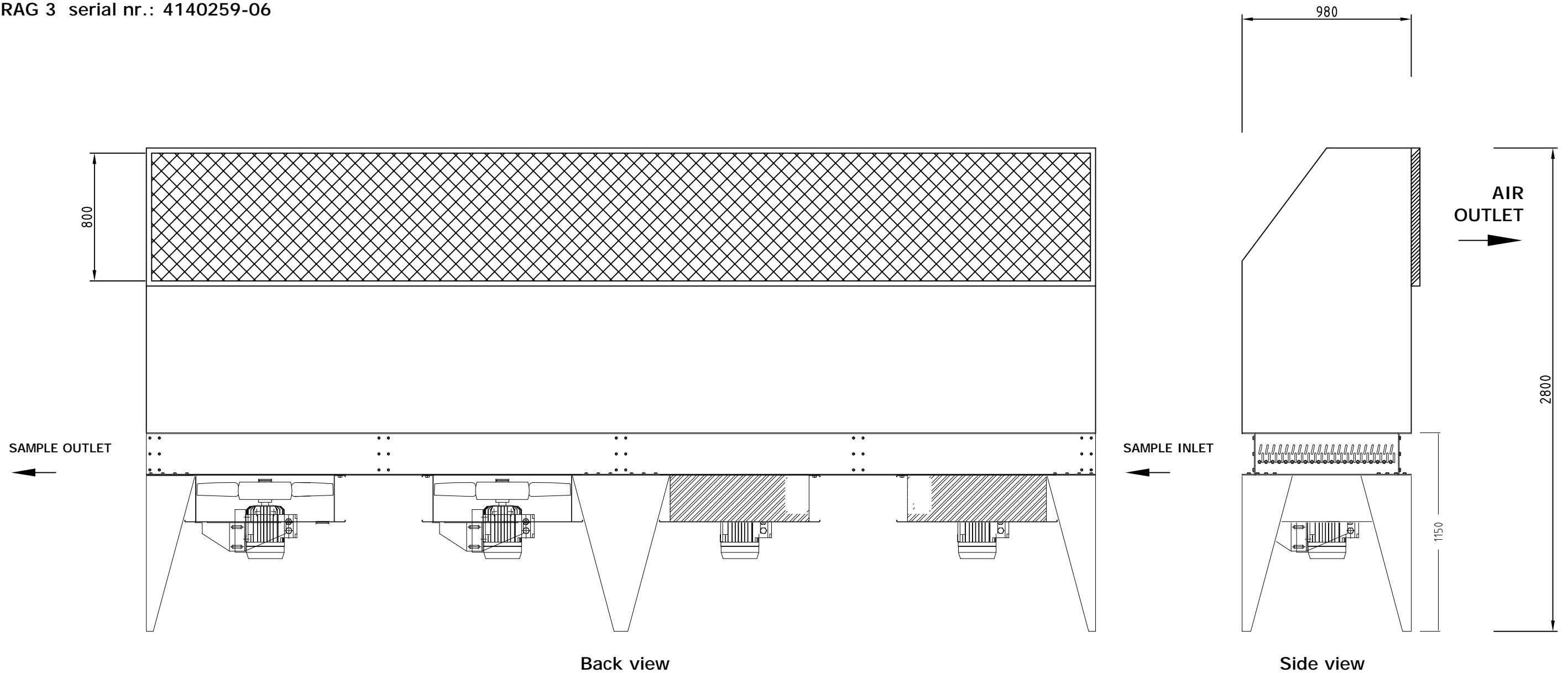

AIRDUCT outlet fan cooler

Rev.	Date	Designer	Checked	Approved	Approved	Remark
D						
C	02.09.2015	PvdS	MR			Revision
B	29.01.2015	PvdS	MR			Revision
A	10.12.2014	PvdS	MR			Revision
0	04.12.2014	PvdS	MR			For approval



Client: NEM Energy BV (Hengelo)
Project: Sample Conditioning Systems
Location: Carmon Creek
Client ref.: 36026
36026-617-14-126-016

Multi Instruments Analytical
Multi Instruments Analytical B.V.
Edisonweg 1
4207 HE
Gorinchem
The Netherlands
Email : analytical@multi-instruments.nl Tel. : +31 (0)183 62 88 88
Web : www.multi-instruments.nl Fax : +31 (0)183 62 81 82

Dim.: mm	MIA Order nr.: S04140259
Scale: 1 : 25	MIA Drawing nr.: 02000510
Form.: A3	File.: V:\Data\Project\414xxxx\4140259 NEM\Acad*.dwg
 American Projection	Erection drawing
	Air cooler steam samples Airduct details
Sheet: 10	



Schematic view of air-cooled tubing

Each stream travels five times up and down the fan-bay

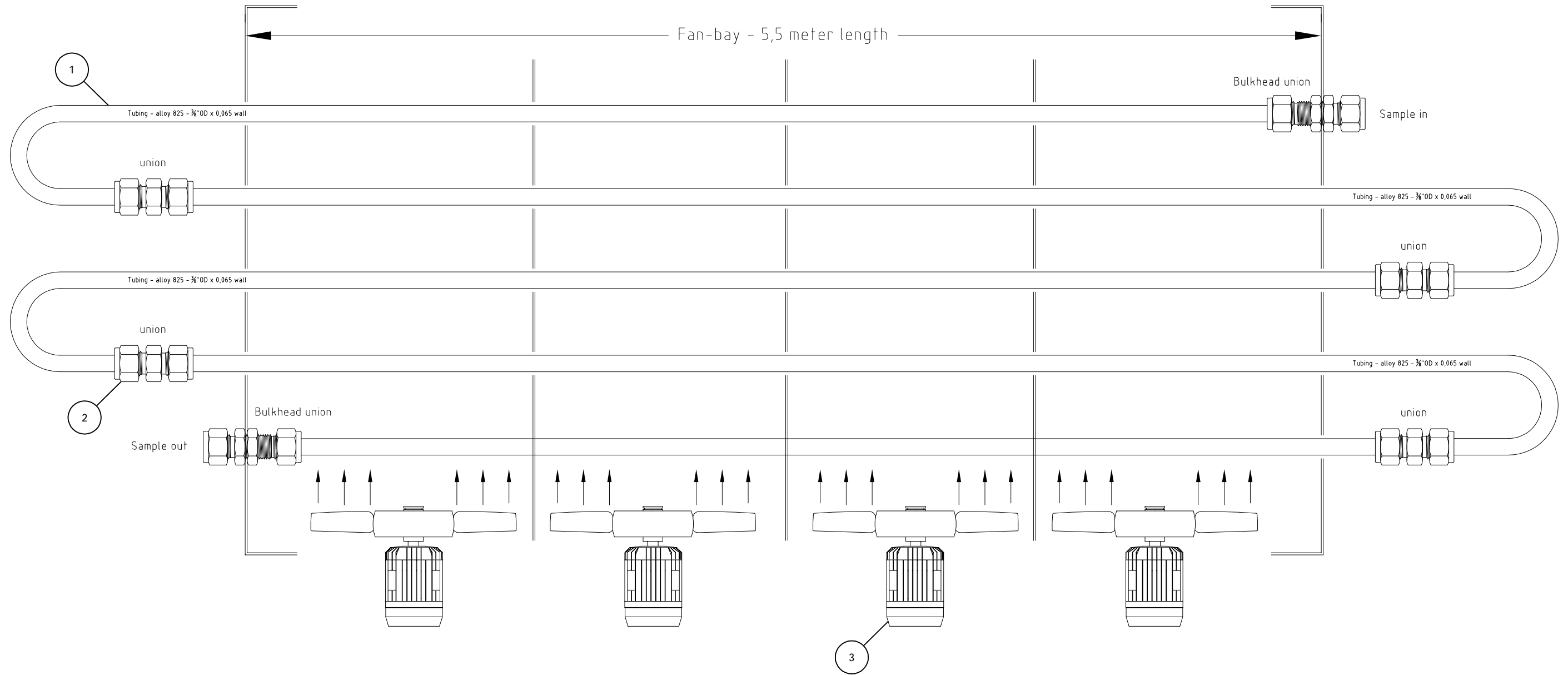

3	Airfan	AISI316 / coated	CSA / Ex Zone 2
2	Twin ferrule fitting	AISI316	CRN 0A6793.52
1	Smls tubing	Alloy 825 3/8" x 0.065"	NACE MR0175
	name/description	material/design	cert
part list			

D						
C						
B						
A						
0	12.03.2015	PvdS	MR			For approval
Rev.	Date	Designer	Checked	Approved	Approved	Remark

Client: NEM Energy B.V. (Hengelo)
 Project: Saple conditioning Systems
 Location: Carmon Creek
 Client ref.: 36026
36026-617-14-126-017

Multi Instruments Analytical B.V.
 Edisonweg 1
 4207 HE
 Gorinchem
 The Netherlands
 Email : analytical@multi-instruments.nl Tel. : +31 (0)183 62 88 88
 Web : www.multi-instruments.nl Fax. : +31 (0)183 62 81 82

Dim.: mm	MIA Order nr.: S04140259
Scale: 1 : 5	MIA Drawing nr.: 01000511
Form.: A3	File.: V:\Data\Project\414xxx\4140259 NEM\Acad\
American Projection	Profile drawing Schematic view



1 2 3 4 5 6 7 8 9 0

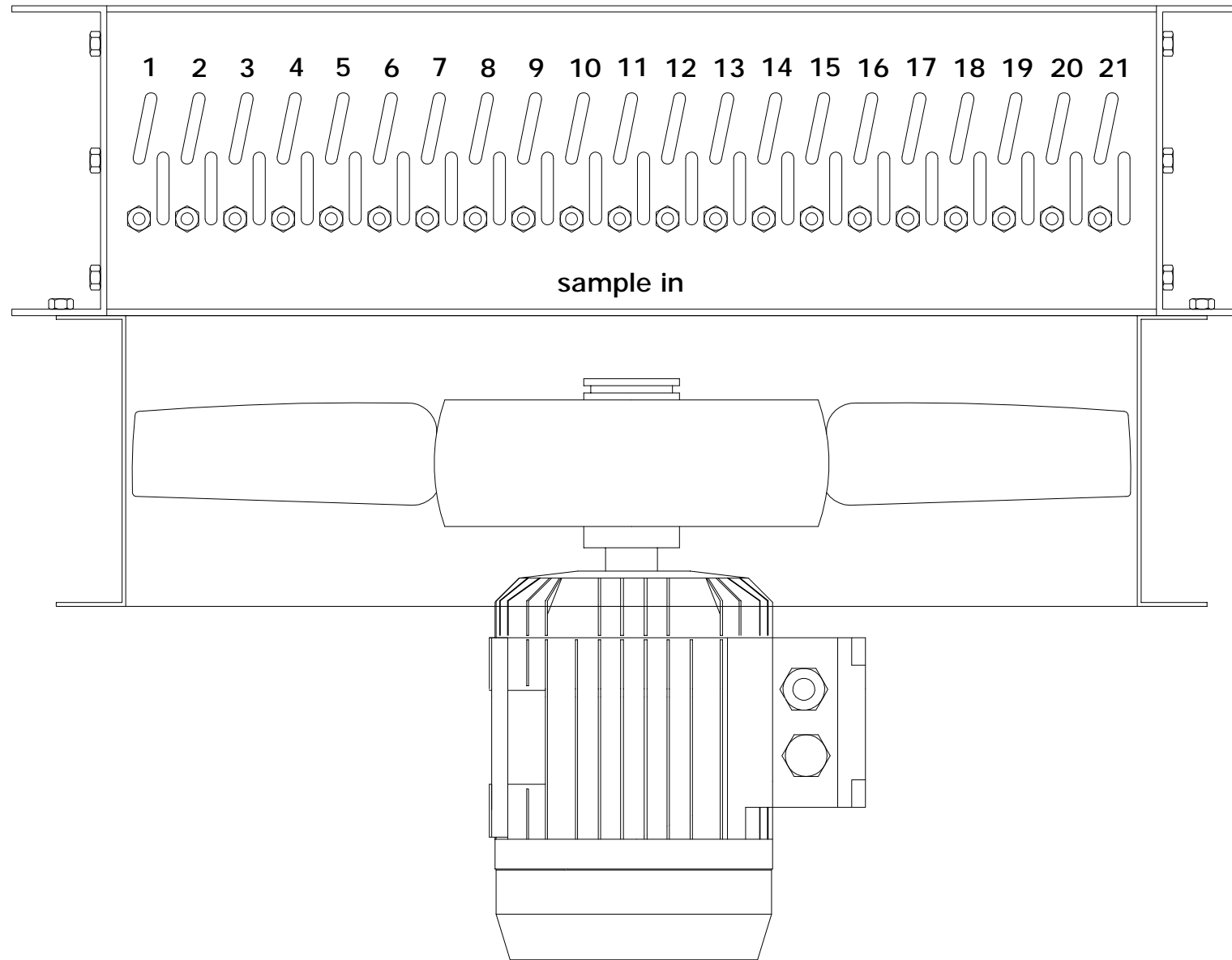

Tubing layout
Maximum total number of streams: 21

D						
C						
B						
A						
0	12.03.2015	PvdS	MR			For approval
Rev.	Date	Designer	Checked	Approved	Approved	Remark

Client: NEM Energy B.V. (Hengelo)
 Project: Saple conditioning Systems
 Location: Carmon Creek
 Client ref.: 36026
36026-617-14-126-018

Multi Instruments Analytical
 Edisonweg 1
 4207 HE
 Gorinchem
 The Netherlands
 Email : analytical@multi-instruments.nl
 Web : www.multi-instruments.nl
 Tel. : +31 (0)183 62 88 88
 Fax. : +31 (0)183 62 81 82

Dim.: mm	MIA Order nr.: S04140259
Scale: 1 : 5	MIA Drawing nr.: 01000512
Form.: A3	File.: V:\Data\Project\414xxx\4140259 NEM\Acad\
	Tubing layout Feed view
American Projection	Sheet: 12

